

SILVERLINE





Built-in Oven User Manual

**MODEL
BO 7005 SR**

Thank you for choosing this product.

This User Manual contains important safety information and instructions on the operation and maintenance of your appliance.

Please take the time to read this User Manual before using your appliance and keep this book for future reference.

Icon	Type	Meaning
	WARNING	Serious injury or death risk
	RISK OF ELECTRIC SHOCK	Dangerous voltage risk
	FIRE	Warning; Risk of fire / flammable materials
	CAUTION	Injury or property damage risk
	IMPORTANT / NOTE	Operating the system correctly

CONTENTS

1.SAFETY INSTRUCTIONS.....	4
1.1 General Safety Warnings	4
1.2 Installation Warnings	6
1.3 During Use	7
1.4 During Cleaning and Maintenance	8
2.INSTALLATION AND PREPARATION FOR USE.....	10
2.1 Instructions for the Installer	10
2.2 Installation of the Oven.....	10
2.3 Electrical Connection and Safety.....	11
3.PRODUCT FEATURES	13
4.USE OF PRODUCT	14
4.1 Cooking Table	15
4.2 Use of the Full Touch Control Pyrolytic Timer.....	15
Adjusting the Minute Minder.....	16
5.CLEANING AND MAINTENANCE.....	19
5.1 Cleaning	19
5.2 Maintenance.....	21
6.TROUBLESHOOTING&TRANSPORT	22
6.1 Troubleshooting.....	22
6.2 Transport	22
7.TECHNICAL SPECIFICATIONS.....	23
7.1 Energy Fiche	23



1. SAFETY INSTRUCTIONS



- Carefully read all instructions before using your appliance and keep them in a convenient place for reference when necessary.
- This manual has been prepared for more than one model therefore your appliance may not have some of the features described within. For this reason, it is important to pay particular attention to any figures whilst reading the operating manual.

1.1 GENERAL SAFETY WARNINGS

- This appliance can be used by children aged from 8 years and above and by persons with reduced physical, sensory or mental capabilities or lack of experience and knowledge if they have been given supervision or instruction concerning use of the appliance in a safe way and understand the hazards involved. Children should not play with the appliance. Cleaning and user maintenance should not be made by children without supervision.



 **WARNING:** The appliance and its accessible parts become hot during use. Care should be taken to avoid touching heating elements. Keep children less than 8 years of age away unless they are continually supervised.

  **WARNING:** Danger of fire: Do not store items on the cooking surfaces.

  **WARNING:** If the surface is cracked, switch off the appliance to avoid the possibility of electric shock.

- Do not operate the appliance with an external timer or separate remote-control system.

- During use the appliance will get hot. Care should be taken to avoid touching heating elements inside the oven.
- Handles may get hot after a short period during use.
- Do not use harsh abrasive cleaners or scourers to clean oven surfaces. They can scratch the surfaces which may result in shattering of the door glass or damage to surfaces.
- Do not use steam cleaners for cleaning the appliance.

  **WARNING:** To avoid the possibility of electric shock, make sure that the appliance is switched off before replacing the lamp.

 **CAUTION:** Accessible parts may be hot when cooking or grilling. Keep young children away from the appliance while it is in use.

- During pyrolytic operations, remove any excess spillage, oven shelves, shelf supports, wire shelves and all accessories before cleaning.
- Your appliance is produced in accordance with all applicable local and international standards and regulations.
- Maintenance and repair work should only be carried out by authorised service technicians. Installation and repair work that is carried out by unauthorised technicians may be dangerous. Do not alter or modify the specifications of the appliance in any way. Inappropriate hob guards can cause accidents.
- Before connecting your appliance, make sure that the local distribution conditions (nature of the gas and gas pressure or electricity voltage and frequency) and the specifications of the appliance are compatible. The specifications for this appliance are stated on the label.

⚠ CAUTION: This appliance is designed only for cooking food and is intended for indoor domestic household use only. It should not be used for any other purpose or in any other application, such as for non-domestic use, in a commercial environment or for heating a room.

- Do not use the oven door handles to lift or move the appliance.
- All possible measures have been taken to ensure your safety. Since the glass may break, care should be taken while cleaning to avoid scratching. Avoid hitting or knocking the glass with accessories.
- Make sure that the supply cord is not trapped or damaged during installation. If the supply cord is damaged, it must be replaced by the manufacturer, its service agent or similarly qualified persons in order to prevent a hazard.
- Do not let children climb on the oven door or sit on it while it is open.
- Please keep children and animals away from this appliance.

1.2 INSTALLATION WARNINGS

- Do not operate the appliance before it is fully installed.
- The appliance must be installed by an authorised technician. The manufacturer is not responsible for any damage that might be caused by defective placement and installation by unauthorised people.
- When the appliance is unpacked, make sure that it has not been damaged during transportation. In the case of a defect do not use the appliance and contact a qualified service agent immediately. The materials used for packaging (nylon, staplers,

styrofoam, etc.) may be harmful to children and they should be collected and removed immediately.

- Protect your appliance against atmospheric effects. Do not expose it to effects such as sun, rain, snow, dust or excessive humidity.
- The material around the appliance must be able to withstand a minimum temperature of 100°C.
- The appliance must not be installed behind a decorative door, in order to avoid overheating.

1.3 DURING USE

- When you first use your oven you may notice a slight smell. This is perfectly normal and is caused by the insulation materials on the heater elements. We suggest that, before using your oven for the first time, you leave it empty and operate it at maximum temperature for 45 minutes. Make sure that the environment in which the product is installed is well ventilated.
- Take care when opening the oven door during or after cooking. The hot steam from the oven may cause burns.
- Do not put flammable or combustible materials in or near the appliance while it is operating.
- Always use oven gloves to remove and replace food in the oven.
- Under no circumstances should the oven be lined with aluminium foil as overheating may occur.
- Do not place dishes or baking trays directly onto the base of the oven whilst cooking. The base becomes very hot and damage may be caused to the product.



Do not leave the oven unattended while cooking with solid or liquid oils. They may catch fire under extreme heating conditions. Never pour water on to

flames that are caused by oil, instead switch the oven off and cover the pan with its lid or a fire blanket.

- If the product will not be used for a long period of time, turn the main control switch off.
- Make sure the appliance control knobs are always in the “0” (stop) position when it is not in use.
- The trays incline when pulled out. Take care not to spill or drop hot food while removing it from the oven.
- Do not place anything on the oven door when it is open. This could unbalance the oven or damage the door.
- Do not hang towels, dishcloths or clothes from the appliance or its handles.

1.4 DURING CLEANING AND MAINTENANCE

- Make sure that your appliance is turned off at the mains before carrying out any cleaning or maintenance operations.
- Do not remove the control knobs to clean the control panel.
- To maintain the efficiency and safety of your appliance, we recommend you always use original spare parts and to call our authorised service agents in case of need.

CE Declaration of conformity

 We declare that our products meet the applicable European Directives, Decisions and Regulations and the requirements listed in the standards referenced.

This appliance has been designed to be used only for home cooking. Any other use (such as heating a room) is improper and dangerous.

 The operating instructions apply to several models. You may notice differences between these instructions and your model.

2. INSTALLATION AND PREPARATION FOR USE

! WARNING : This appliance must be installed by an authorised service person or qualified technician, according to the instructions in this guide and in compliance with the current local regulations.

- Incorrect installation may cause harm and damage, for which the manufacturer accepts no responsibility and the warranty will not be valid.
- Prior to installation, ensure that the local distribution conditions (electricity voltage and frequency) and the adjustments of the appliance are compatible. The adjustment conditions for this appliance are stated on the label.
- The laws, ordinances, directives and standards in force in the country of use are to be followed (safety regulations, proper recycling in accordance with the regulations, etc.).

2.1 INSTRUCTIONS FOR THE INSTALLER

General instructions

- After removing the packaging material from the appliance and its accessories, ensure that the appliance is not damaged. If you suspect any damage,

do not use it and contact an authorised service person or qualified technician immediately.

- Make sure that there are no flammable or combustible materials in the close vicinity, such as curtains, oil, cloth etc. which may catch fire.
- The worktop and furniture surrounding the appliance must be made of materials resistant to temperatures above 100°C.
- The appliance should not be installed directly above a dishwasher, fridge, freezer, washing machine or clothes dryer.

2.2 INSTALLATION OF THE OVEN

The appliances are supplied with installation kits and can be installed in a worktop with the appropriate dimensions. The dimensions for hob and oven installation are given below.

A (mm)	557	min./max. F (mm)	560/580
B (mm)	550	min. G (mm)	555
C (mm)	595	min. H/I (mm)	600/590
D (mm)	575	min. J/K (mm)	5/10
E (mm)	574		

Installation under a worktop

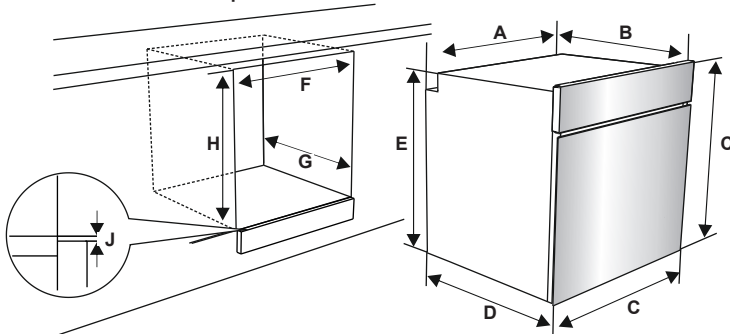

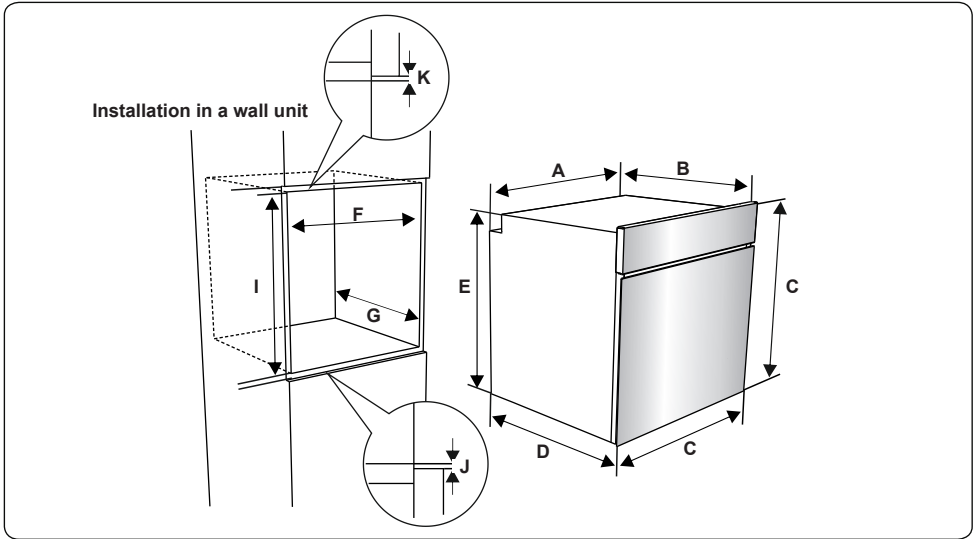

After making the electrical connections, insert the oven into the cabinet by pushing it forward. Open the oven door and insert 2 screws in the holes located on the oven frame. While the product frame touches the wooden surface of the cabinet, tighten the screws.

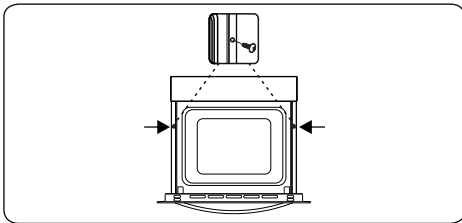

2.3 ELECTRICAL CONNECTION AND SAFETY

WARNING: The electrical connection of this appliance should be carried out by an authorised service person or qualified electrician, according to the instructions in this guide and in compliance with the current local regulations.

WARNING: THE APPLIANCE MUST BE EARTHED.

- Before connecting the appliance to the power supply, the voltage rating of the appliance (stamped on the appliance identification plate) must be checked for correspondence to the available mains supply voltage, and the mains electric wiring should be capable of handling the appliance's power rating (also indicated on the identification plate).
- During installation, please ensure that isolated cables are used. An incorrect connection could damage your appliance. If the mains cable is damaged and needs to be replaced this should be done by a qualified personnel.
- Do not use adaptors, multiple sockets and/or extension leads.
- The supply cord should be kept away from hot parts of the appliance and must not be bent or compressed. Otherwise the cord may be damaged, causing a short circuit.
- If the appliance is not connected to the mains with a plug, a all-pole disconnector (with at least 3 mm contact spacing) must be used in order to meet the safety regulations.

- The appliance is designed for a power supply of 220-240V ~ and 380-415V 3N~. If your supply is different, contact the authorised service person or a qualified electrician.
- The power cable (H05VV-F) must be long enough to be connected to the appliance, even if the appliance stands on the front of its cabinet.
- Ensure all connections are adequately tightened.
- Fix the supply cable in the cable clamp and then close the cover.
- The terminal box connection is placed on the terminal box.

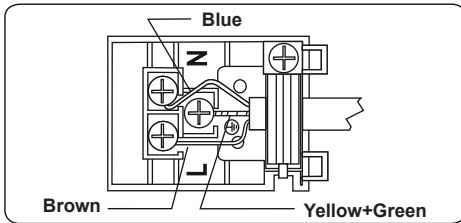

3. PRODUCT FEATURES

 **Important:** Specifications for the product vary and the appearance of your appliance may differ from that shown in the figures below.

List of Components

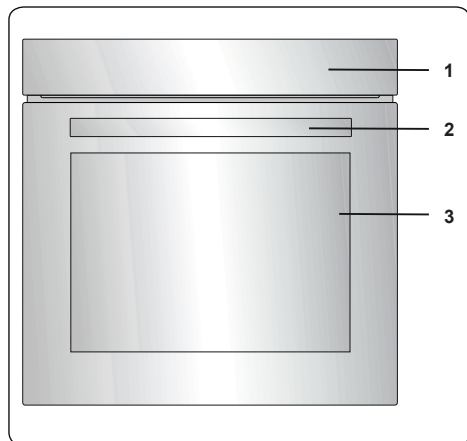

1. Control Panel
2. Oven Door Handle
3. Oven Door

Control Panel

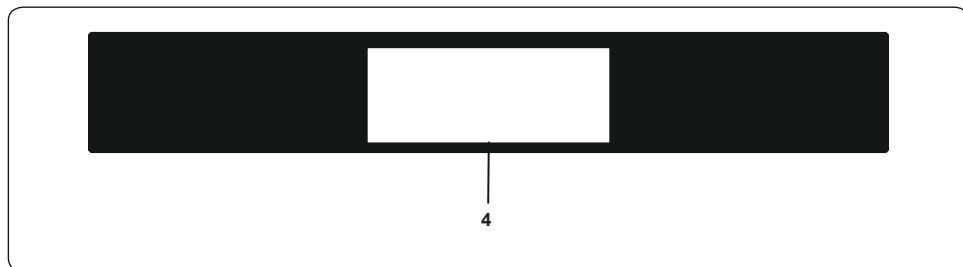

4. Timer

4. USE OF PRODUCT

Oven Functions

* The functions of your oven may be different due to the model of your product.



Defrost Function: The oven's warning lights will switch on and the fan will start to operate. To use the defrost function, place your frozen food in the oven

on a shelf in the third slot from the bottom. It is recommended that you place an oven tray under the defrosting food to catch the water accumulated due to melting ice. This function will not cook or bake your food, it will only help to defrost it.

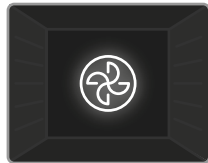

Turbo Function: The oven's thermostat and warning lights will switch on, and the ring heating element and fan will start operating. The turbo function

evenly disperses the heat in the oven so all food on all racks will cook evenly. It is recommended that you preheat the oven for about 10 minutes.

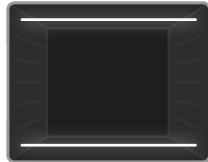

Static Cooking Function: The oven's thermostat and warning lights will switch on, and the lower and upper heating elements will start operating. The

static cooking function emits heat, ensuring even cooking of food. This is ideal for making pastries, cakes, baked pasta, lasagne and pizza. Preheating the oven for 10 minutes is recommended and it is best to use only one shelf at a time in this function.

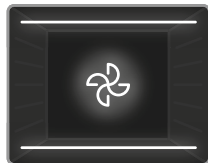

Fan Function: The oven's thermostat and warning lights will switch on, and the upper and lower heating elements and fan will start operating.

This function is good for baking pastry. Cooking is carried out by the lower and upper heating elements within the oven and by the fan, which provides air circulation, giving a slightly grilled effect to the food. It is recommended that you preheat the oven for about 10 minutes.

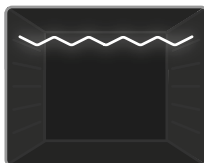

Grilling Function: The oven's thermostat and warning lights will switch on, and the grill heating element will start operating. This function is used for grilling and toasting foods on the upper shelves of the oven. Lightly brush the wire grid with oil to stop food sticking and place food in the centre of the grid. Always place a tray beneath the food to catch any drips of oil or fat. It is recommended that you preheat the oven for about 10 minutes.



Warning: When grilling, the oven door must be closed and the oven temperature should be adjusted to 190°C.

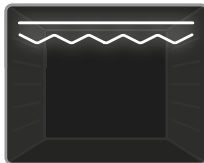

Faster Grilling Function: The oven's thermostat and warning lights will switch on, and the grill and upper heating elements will start

operating. This function is used for faster grilling and for grilling food with a larger surface area, such as meat. Use the upper shelves of the oven. Lightly brush the wire grid with oil to stop food sticking and place food in the centre of the grid. Always place a tray beneath the food to catch any drips of oil or fat. It is recommended that you preheat the oven for about 10 minutes.



Warning: When grilling, the oven door must be closed and the oven temperature should be adjusted to 190°C.

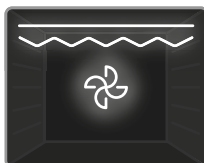

Double Grill and Fan Function: The oven's thermostat and warning lights will switch on, and the grill, upper heating elements and fan will

start operating. This function is used for faster grilling of thicker food and for grilling of food with a larger surface area. Both the upper heating elements and grill will be energised along with the fan to ensure even cooking. Use the upper shelves of the oven. Lightly brush the wire grid with oil to stop food sticking and place food in the centre of the grid. Always place a tray beneath the food to catch any drips of oil or fat. It is recommended that you preheat the oven for about 10 minutes.



Warning: When grilling, the oven door must be closed and the oven temperature should be adjusted to 190°C.

Pyrolytic Cleaning Function: This function allows you to clean the inside of the oven thoroughly.

Warning: Before activating the pyrolytic cleaning function, remove any excessive spillage and make sure that the oven is empty. Do not leave anything inside the oven cavity in order to prevent damage.

- Before activating the pyrolytic cleaning function, remove the wire oven shelves and shelf supports (if available) and ensure the oven door is closed.
- The oven door will lock when the pyrolytic function starts.
- When the pyrolytic cleaning function is on, it is advisable not to use a hob if it is fitted above the oven. This could cause overheating and damage to both appliances.
- During the pyrolytic cleaning cycle the oven door will become hot. Children should be kept away until it has cooled.
- At the end of pyrolytic cleaning process, the display will show the time of day.









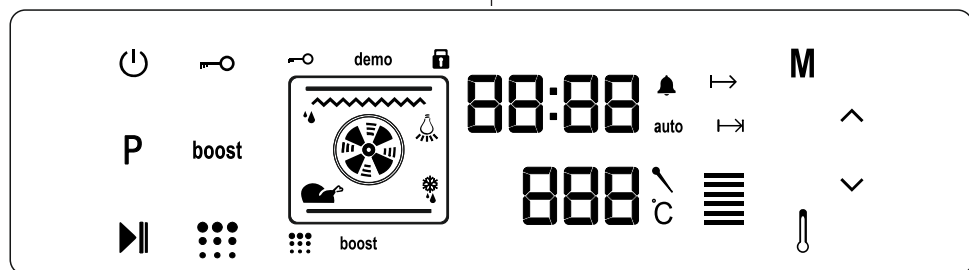



4.1 COOKING TABLE

Function	Dishes			 min.
Static	Puff Pastry	2-3-4	170-190	35-45
	Cake	2-3-4	170-190	30-40
	Cookie	2-3-4	170-190	30-40
	Stew	2	175-200	40-50
	Chicken	2-3-4	200	45-60
Fan	Puff Pastry	2-3-4	170-190	25-35
	Cake	2-3-4	150-170	25-35
	Cookie	2-3-4	150-170	25-35
	Stew	2	175-200	40-50
	Chicken	1 - 2	200	45-60
Turbo	Puff Pastry	2-3-4	170-190	35-45
	Cake	2-3-4	150-170	30-40
	Cookie	2-3-4	150-170	25-35
	Stew	2	175-200	40-50
Grilling	Grilled meatballs	5	200	10-15
	Chicken	*	190	50-60
	Chop	4-5	200	15-25
	Beefsteak	5	200	15-25

*If available cook with roast chicken skewer.

4.2 USE OF THE FULL TOUCH CONTROL PYROLYTIC TIMER



Mode Descriptions					
	On/Off		Key lock		Plus
	Function selection		Boost		Minus
	Play/Pause		Thermostat		Temperature display
	Mode		Time display		Pyrolytic cleaning

The control unit will switch off after 5 minutes if no function is selected or changed.

The appliance is operated using touch control sensors. The functions are controlled by touching the sensor fields.

When you are using the controls, make sure that you touch the sensor field correctly. If your touch is too flat or too small the sensors will not operate correctly.

The cooling fan will switch on automatically in order to keep the surfaces of the appliance cool. The fan will continue to run until it automatically switches off, even after the oven has been switched off.

Oven Function Selection

Touch the **ON/OFF** sensor for 2 seconds to switch the control unit on. The oven will enter **"WAIT"** mode. During this mode, you will be able to select the desired cooking functions, adjust the temperature, activate the **BOOST** function, as well as adjust the cooking time, end time, Minute Minder timer and the time of day.

During **"WAIT"** mode, the desired cooking function can be selected by touching the **P** sensor button. Each touch on the **P** sensor will change the oven function, as shown below (some of these cooking functions may not be present in your cooker model):

Lamp → Defrost → Turbo → Upper and Lower → Upper and Lower with Fan → Grill (with/without turnspit) → Double Grill (with/without turnspit) → Double Grill with Fan (with/without turnspit).

The operated heaters and accessories related to the selected function will be displayed.

When a cooking function is selected using the **P** sensor, the previously selected temperature value will show on the Temperature display. This can be adjusted using the **PLUS** and **MINUS** sensor buttons on the side of the display. The temperature can be adjusted within the range of 50°C to

275°C.

After the desired function has been selected, and the temperature and time are set, touch the **START/STOP** sensor to start the oven function operation.

Adjusting the Time of Day

When the oven has been installed, the time of day must be set according to the following instructions.

Touch the **ON/OFF** sensor to switch the oven on and enter **"WAIT"** mode. During this mode, touch the **MODE** sensor button until the time is selected. The symbol for the time will illuminate on the left side and you can adjust it using the **PLUS** and **MINUS** sensor buttons. To complete the time adjustment, touch the **MODE** sensor once again.

The time will only have to be set again if the appliance is disconnected from the power supply for a long period of time.

Adjusting the Cooking Time

The cooking time can be adjusted during **"WAIT"** mode or during **"OPERATING"** mode.

Adjusting the Minute Minder

Touch the **MODE** sensor until the Minute Minder symbol illuminates on the Time display and **"00:00"** appears. Adjust the desired time period for the warning signal using the **PLUS** and **MINUS** sensor buttons while the symbol is flashing. When you have completed the adjustment, do not press any buttons for a few seconds, then the Minute Minder timer will be set.

When the timer reaches zero, an audible warning will sound, and the Minute Minder symbol and **"00:00"** will flash on the Time display. Press any button to stop the audible warning and the symbol will disappear.

Adjusting the Cooking Duration Time

This function helps you to cook for a fixed period of time. Prepare the food

for cooking and put it in the oven. Then, select the desired cooking function and the temperature. Touch the **MODE** sensor button until you see the Duration Time symbol on the Time display. Set the required cooking period using the **PLUS** and **MINUS** sensors while the timer is in this position. When you have completed the adjustment, wait until the current time of day is displayed and until the Duration Time symbol remains illuminated.

When the timer reaches zero, the oven will switch off, an audible warning will sound and the Duration Time symbol will flash on the Time display. Touch any sensor on the control unit to end the sound.

Adjusting the Cooking End Time

This function is used to begin cooking after a certain period of time and for a specific duration of time. Prepare the food for cooking and put it in the oven. Then, select the desired cooking function and the temperature.

Touch the **MODE** button until you see the Cooking Duration Time symbol on the Time display. Set the required cooking period using the **PLUS** and **MINUS** sensor while the timer is in this position. When you have completed the adjustment, wait until the current time of day is displayed and until the Cooking Duration Time symbol remains illuminated.

Then, touch the **MODE** sensor button until you see the Cooking End Time symbol on the Time display. The time of day and the Cooking Duration Time symbol will flash. Set the required finish time using the **PLUS** and **MINUS** sensors while the timer is in this position. When you have completed the adjustment, wait until the current time of day is displayed and until the Cooking End Time symbol remains illuminated.

The oven will calculate the operating time by deducting the cooking period from the set finishing time, at which it will stop operating. The timer will give an audible warning and the Cooking End Time symbol will flash. Touching any button on the timer will end the audible warning.

Digital Timer Sound Adjustment

To alter the warning signal sound, while the Time display shows the time of day, press and hold the **MINUS** sensor button for 2 seconds until there is an audible signal sound. After this, each time the **MINUS** sensor is pressed, a different signal will sound. There are three different types of

signal sound. Select the desired sound and do not press any other buttons. After a short time, the selected signal sound will be saved.

Boost Function

This function is used to shorten the preheating time. The **BOOST** sensor will illuminate when the Turbo, Fan, Static or Pizza functions are selected. To save preheating time, touch the **BOOST** sensor button before starting a cooking operation.

Use this function to heat the oven the desired temperature as quickly as possible. This mode is not appropriate for cooking.

Key Lock Function

The key lock is used to avoid unintentional changes to oven settings.

To activate the key lock, touch the **KEY LOCK** sensor button for 2 seconds until you see Key Lock symbol on the display. To deactivate the key lock, touch the **KEY LOCK** sensor for 2 seconds until the key lock symbol disappears from the display.

When the key lock is engaged, only the **ON/OFF** sensor button can be activated. All other buttons will remain locked.

Accessories

The EasyFix Wire Rack

Clean the accessories thoroughly with warm water, detergent and a soft clean cloth on first use.

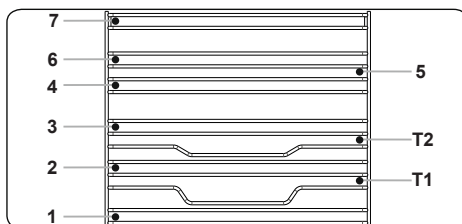

- Insert the accessory to the correct position inside the oven.
- Allow at least a 1 cm space between the fan cover and accessories.
- Take care removing cookware and/or accessories out of the oven. Hot meals or accessories can cause burns.
- The accessories may deform with heat. Once they have cooled down, they will recover their original appearance and performance.

- Trays and wire grids can be positioned on any level from of 1 to 7.
- Telescopic rail can be positioned on levels T1, T2, 3, 4, 5, 6, 7.
- Level 3 is recommended for single level cooking.
- Level T2 is recommended for single level cooking with the telescopic rails.
- Level 2 and Level 4 are recommended for double level cooking.
- The turnspit wire grid must be positioned on Level 3.
- Level T2 is used for turnspit wire grid positioning with the telescopic rails.

****Accessories may vary depending on the model purchased.

The Deep Tray

The deep tray is best used for cooking stews.

Put the tray into any rack and push it to the end to make sure it is placed correctly.

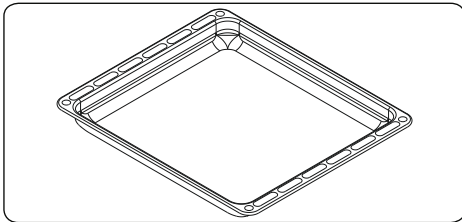

The Shallow Tray

The shallow tray is best used for baking pastries.

Put the tray into any rack and push it to the end to make sure it is correctly placed.

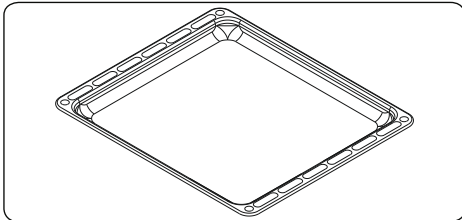

Wire Rack with Easyfix Full Extension Telescopic Rail

The telescopic rail extends out fully to allow easy access to your food.

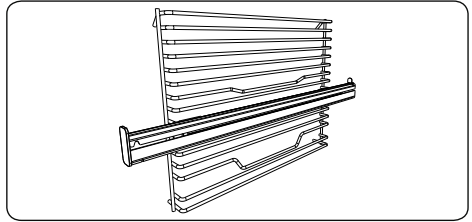

Telescopic rails

Clean the accessories thoroughly with warm water, detergent and a soft clean cloth on first use.

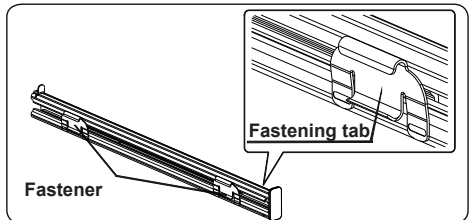

- Positioning of the telescopic rails on the wire rack is secured with the fastening tabs on the fasteners.
- Remove the side runner. See section "Removal of the wire shelf".

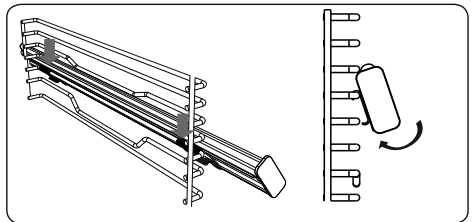

- On each telescopic rail there are top and bottom fasteners that allows you to reposition the rails.
- Hang the telescopic rail top fasteners on the side rack level reference wire and simultaneously press the bottom fasteners until you clearly hear the fasteners clip into the side rack level fixing wire.
- In order to remove, hold the front surface of the rail and follow the previous instructions in reverse.

The Wire Grid

The wire grid is best used for grilling or for processing food in oven-friendly containers.

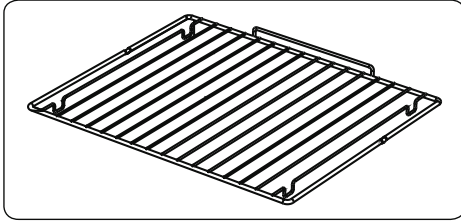

WARNING

Place the grid to any corresponding rack in the oven cavity correctly and push it to the end.

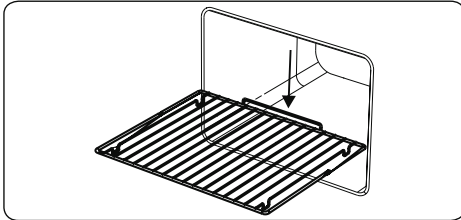

The Water Collector

In some cases of cooking, condensation may appear on the inner glass of the oven door. This is not a product malfunction.

Open the oven door into the grilling position and leave it in this position for 20 seconds.

Water will drip to the collector.

Cool the oven and wipe the inside of the door with a dry towel. This procedure must be applied regularly.

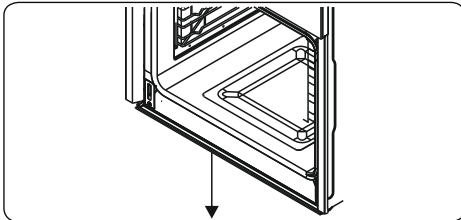

5. CLEANING AND MAINTENANCE

5.1 CLEANING

 **WARNING:** Switch off the appliance and allow it to cool before cleaning is to be carried out.

General Instructions

- Check whether the cleaning materials are appropriate and recommended by the manufacturer before use on your appliance.
- Use cream cleaners or liquid cleaners which do not contain particles. Do not use caustic (corrosive) creams, abrasive cleaning powders, rough wire wool or hard tools as they may damage the cooker surfaces.

 Do not use cleaners that contain particles as they may scratch the glass, enamelled and/or painted parts of your appliance.

- Should any liquids overflow, clean them immediately to avoid parts becoming damaged.

 Do not use steam cleaners for cleaning any part of the appliance.

Cleaning the Inside of the Oven

- The inside of enamelled ovens are best cleaned while the oven is warm.
- Wipe the oven with a soft cloth soaked in soapy water after each use. Then, wipe the oven over again with a wet cloth and dry it.
- You may need to use a liquid cleaning material occasionally to completely clean the oven.

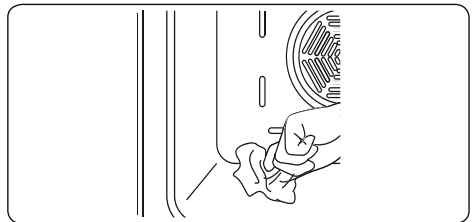

Pyrolytic cleaning

WARNING: Before activating the pyrolytic cleaning function, remove any excessive spillage and make sure that the oven is empty. Do not leave anything inside the oven, such as wire grids, trays, or oven shelves and supports (if available), as they could be damaged during pyrolytic cleaning.

- The oven cavity is coated with a special enamel that is resistant to high temperatures. During the pyrolytic cleaning operation, the temperature inside the oven can reach about 475°C.
- The oven door will automatically lock, for your safety, while the pyrolytic cleaning function is in operation. After the cleaning is complete, the cooling fan will begin operating and the oven will remain locked until it has cooled.
- It is advisable to wipe the oven down with a sponge soaked in warm water, after each cooking operation or pyrolytic cleaning cycle has been carried out.
- During the pyrolytic operation, a smell and some fumes will emanate due to the destruction of food residue within the oven. This is normal. Oven cleaning fumes could be fatal to birds, children and pets so all should be kept away until the operation is complete.
- The area where the oven is installed should be kept well-ventilated, especially during the pyrolytic cleaning function, and any doors leading into the area should be closed to avoid passing the smell and fumes throughout.

Cleaning the Glass Parts

- Clean the glass parts of your appliance on a regular basis.
- Use a glass cleaner to clean the inside and outside of the glass parts. Then, rinse and dry them thoroughly with a dry cloth.

Cleaning the Stainless Steel Parts (if available)

- Clean the stainless steel parts of your appliance on a regular basis.
- Wipe the stainless steel parts with a soft cloth, soaked in only water. Then, dry them thoroughly with a dry cloth.



Do not clean the stainless steel parts while they are still hot from cooking.



Do not leave vinegar, coffee, milk, salt, water, lemon or tomato juice on the stainless steel for a long time.

Cleaning Painted Surfaces (if available)

- Spots of tomato, tomato paste, ketchup, lemon, oil derivatives, milk, sugary foods, sugary drinks and coffee should be cleaned with a cloth dipped in warm water immediately. If these stains are not cleaned and allowed to dry on the surfaces they are on, they should NOT be rubbed with hard objects (pointed objects, steel and plastic scouring wires, surface-damaging dish sponge) or cleaning agents containing high levels of alcohol, stain removers, degreasers, surface abrasive chemicals. Otherwise, corrosion may occur on the powder painted surfaces, and stains may occur. The manufacturer will not be held responsible for any damage caused by the use of inappropriate cleaning products or methods.

Removal of the Inner Glass

You must remove the oven door glass before cleaning, as shown below.

1. Push the glass in the direction of **B** and release from the location bracket (**x**). Pull the glass out in the direction of **A**.

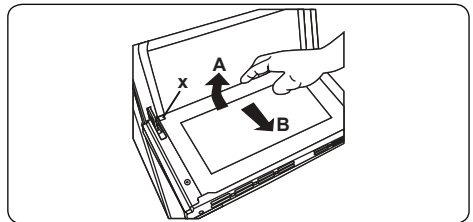

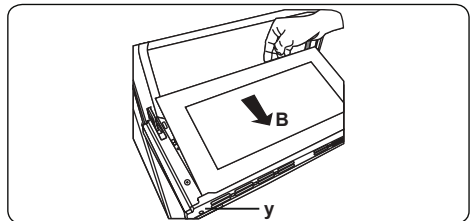

To replace the inner glass:

1. Push the glass towards and under the location bracket (**y**), in the direction of **B**.

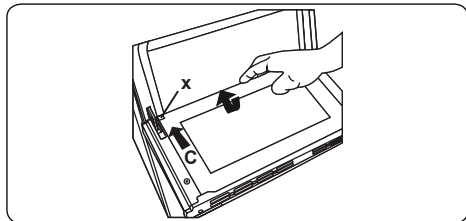

3. Place the glass under the location bracket (x) in the direction of C.



 If the oven door is a triple glass oven door, the third glass layer can be removed the same way as the second glass layer.

Removal of the Oven Door

Before cleaning the oven door glass, you must remove the oven door, as shown below.

1. Open the oven door.

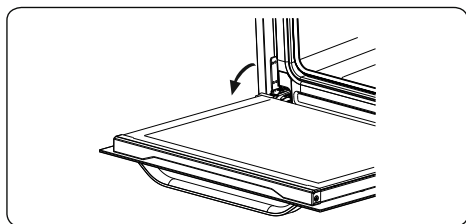

2. Open the locking catch (a) (with the aid of a screwdriver) up to the end position.

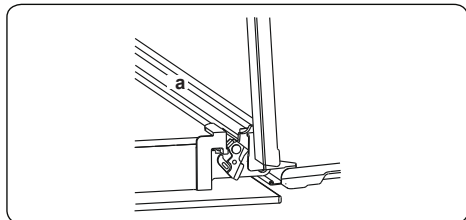

3. Close the door until it is almost in the fully closed position, and remove the door by pulling it towards you.

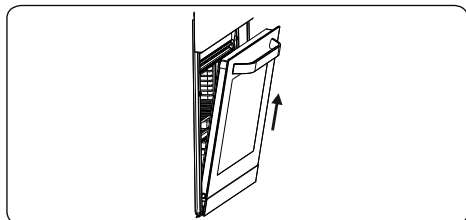

Removal of the Wire Shelf

To remove the wire rack, pull the wire rack as shown in the figure. After releasing it from the clips (a), lift it up.

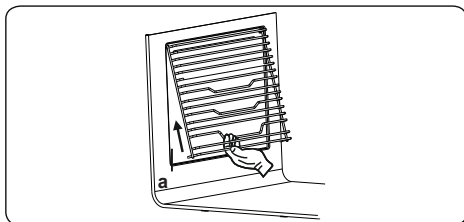

5.2 MAINTENANCE

 **WARNING:** The maintenance of this appliance should be carried out by an authorised service person or qualified technician only.

Changing the Oven Lamp

 **WARNING:** Switch off the appliance and allow it to cool before cleaning your appliance.

- Remove the glass lens, then remove the bulb.
- Insert the new bulb (resistant to 300 °C) to replace the bulb that you removed (230 V, 15-25 Watt, Type E14).
- Replace the glass lens, and your oven is ready for use.

 The lamp is designed specifically for use in household cooking appliances. It is not suitable for household room illumination.

6. TROUBLESHOOTING&TRANSPORT

6.1 TROUBLESHOOTING



If you still have a problem with your appliance after checking these basic troubleshooting steps, please contact an authorised service person or qualified technician.

Problem	Possible Cause	Solution
Oven does not switch on.	Power is switched off.	Check whether there is power supplied. Also check that other kitchen appliances are working.
No heat or oven does not warm up.	Oven temperature control is incorrectly set. Oven door has been left open.	Check that the oven temperature control knob is set correctly.
Oven light (if available) does not operate.	Lamp has failed. Electrical supply is disconnected or switched off.	Replace lamp according to the instructions. Make sure the electrical supply is switched on at the wall socket outlet.
Cooking is uneven within the oven.	Oven shelves are incorrectly positioned.	Check that the recommended temperatures and shelf positions are being used. Do not frequently open the door unless you are cooking things that need to be turned. If you open the door often, the interior temperature will be lower and this may affect the results of your cooking.
The appliance door cannot be opened; the door lock symbol or signal lamp lights up on the display.	The appliance door is locked due to the pyrolytic function.	Wait until the cooking compartment has cooled and the door lock symbol goes out.
The timer buttons cannot be pressed properly.	There is foreign matter caught between the timer buttons. Touch model: there is moisture on the control panel. The key lock function is set.	Remove the foreign matter and try again. Remove the moisture and try again. Check whether the key lock function is set.
The oven fan is noisy.	Oven shelves are vibrating.	Check that the oven is level. Check that the shelves and any bake ware are not vibrating or in contact with the oven back panel.
After the "pyrolysis" cleaning cycle, it is not possible to select a function.	The oven cools itself by operating the cooling fan after "pyrolysis".	Verify whether the door locking device has switched off. If it has not, the oven is still in the cooling period. During the cooling fan period, no cooking function can be operated.

6.2 TRANSPORT

If you need to transport the product, use the original product packaging and carry it using its original case. Follow the transport signs on the packaging. Tape all independent parts to the product to prevent damaging the product during transport.

If you do not have the original packaging, prepare a carriage box so that the appliance, especially the external surfaces of the product, is protected against external threats.

7. TECHNICAL SPECIFICATIONS

7.1 ENERGY FICHE

Brand		SILVERLINE
Model		BO 7005 SR
Type of Oven		ELECTRIC
Mass	kg	37,2
Energy Efficiency Index - conventional		106,0
Energy Efficiency Index - fan forced		94,6
Energy Class		A
Energy consumption (electricity) - conventional	kWh/cycle	0,93
Energy consumption (electricity) - fan forced	kWh/cycle	0,83
Number of cavities		1
Heat Source		ELECTRIC
Volume	l	
This oven complies with EN 60350-1		78
Energy Saving Tips		
Oven		
- Cook the meals together, if possible.		
- Keep the pre-heating time short.		
- Do not elongate cooking time.		
- Do not forget to turn-off the oven at the end of cooking.		
- Do not open oven door during cooking period.		

Rev.07122020

www.silverline.com

MANUFACTURER COMPANY

SILVERLINE Ev Gereçleri Satış ve Pazarlama A.Ş.
Orta Mah. Topkapı Maltepe Cad. No: 6 Silkar Plaza Kat: 3
Bayrampaşa / İstanbul P.K. 34030
Tel: 0 212 484 48 00 Faks: 0 212 481 40 08